

ACC Series Chillers

Installation, Operation, & Maintenance



Jetson
Excellence in HVAC

Contents

Safety	6
Model Number Description	8
Digits 4 — Chiller Type.....	10
Digits 5 to 7 — Nominal Capacity.....	10
Digit 8 — Unit Voltage.....	10
Digit 9 — Unit Application	11
Digit 10 — Steps of Capacity	11
Digit 11 — Refrigerant Type	11
Digit 12 — Efficiency.....	12
Digit 13 — Design Sequence.....	12
Digit 14 — Evaporator Heat Exchanger Type.....	12
Digit 15 — Evaporator Temperature Range.....	12
Digit 16 — Evaporator Flow and Valves.....	13
Digit 17 — Condenser Heat Exchanger Type	13
Digit 18 — Condenser Fan Control	13
Digit 19 — Condenser Heat Recovery	14
Digit 20 — Condenser Heat Recover Control Valves	14
Digit 21 — Power Connection.....	15
Digit 22 — Power Feed	15
Digit 23 — Service Options.....	16
Digit 24 — Control Style	17
Digit 25 — Local Unit Controller Interface.....	17
Digit 26 — Remote BMS Interface (Digital Comm).....	17
Digit 27 — Blank.....	18
Digit 28 — Refrigeration Options	18
Digit 29 — Refrigeration Accessories	18
Digit 30 — Water Connection	19
Digit 31 — Water Side Pressure	19
Digit 32 — Water Strainer(s).....	19
Digit 33 — Water Accessories.....	19
Digit 34 — Free Cooling	20
Digit 35 — Sound Attenuator	20

Digit 36 — Guards	20
Digit 37 — Exterior Finish and Shipping Splits	20
Digit 38 — Warranty	21
Digit 39 — Special Options	21
General Information	22
Receiving Unit	22
Storage	23
Wiring Diagrams	23
General Maintenance	24
Primary Pumping Package	24
Glycol	24
Compression Tank	24
Pressure Relief Valve	24
Dual Pumps	24
Pipe Insulation	25
Installation	25
Forklifting the unit	25
Lifting the Unit	25
Typical Water Piping	27
Avoidance of Short Water Loops	29
Minimum Water Volume for a Process Application	30
Water Connection	30
Mounting Isolation	31
Access Doors	31
Electrical	31
Sample Electrical Diagram	33
Startup	35
Maintenance	36
General	36
Compressors	36
Refrigerant Filter Driers	36
Evaporator	36
Adjusting Refrigerant Charge	36

Lubrication	40
Service.....	40
Warranties	40
Pump Operation	40
Maintenance Recommendations	40
Pump Bearings - Lubrication	40
Air Inlet	40
Propeller Fans and Motors	40
Recommended Annual Inspection	41
Air-Cooled Condenser	41
Microchannel Coil Cleaning	41
Microchannel Coil Cleaning Considerations	43
E-Coated Coil Cleaning	43
Limited Product Warranty	47
ACC Chillers Startup Form.....	50
Maintenance Log.....	53
Literature Change History.....	54

Safety

Attention should be paid to the following statements:

NOTE - Notes are intended to clarify the unit installation, operation and maintenance.

 **CAUTION** - Caution statements are given to prevent actions that may result in equipment damage, property damage, or personal injury.

 **WARNING** - Warning statements are given to prevent actions that could result in equipment damage, property damage, personal injury or death.

 **DANGER** - Danger statements are given to prevent actions that will result in equipment damage, property damage, severe personal injury or death.



WARNING

ELECTRIC SHOCK, FIRE OR EXPLOSION HAZARD

Failure to follow safety warnings exactly could result in dangerous operation, serious injury, death or property damage.

Improper servicing could result in dangerous operation, serious injury, death, or property damage.

- Before servicing, disconnect all electrical power to the furnace. More than one disconnect may be provided.
- When servicing controls, label all wires prior to disconnecting. Reconnect wires correctly.
- Verify proper operation after servicing. Secure all doors with key-lock or nut and bolt.



WARNING

QUALIFIED INSTALLER

Improper installation, adjustment, alteration, service or maintenance can cause property damage, personal injury or loss of life. Startup and service must be performed by a trained service technician. A copy of this manual should be kept with the unit.



WARNING

Electric shock hazard. Shut off all electrical power to the unit to avoid shock hazard or injury from rotating parts.



CAUTION

PVC (Polyvinyl Chloride) and CPVC (Chlorinated Polyvinyl Chloride) are vulnerable to attack by certain chemicals. Polyolester (POE) oils used with R-410A and other refrigerants, even in trace amounts, in a PVC or CPVC piping system will result in stress cracking of the piping and fittings and complete piping system failure.



WARNING

VARIABLE FREQUENCY DRIVES

Do not leave VFDs unattended in hand mode or manual bypass. Damage to personnel or equipment can occur if left unattended. When in hand mode or manual bypass mode VFDs will not respond to controls or Alarms.

1. Startup and service must be performed by a trained service technician.
2. The unit is for outdoor use only.
3. Every unit has a unique equipment nameplate with electrical, operational, and unit clearance specifications. Always refer to the unit nameplate for specific ratings unique to the model you have purchased.
4. READ THE ENTIRE INSTALLATION, OPERATION AND MAINTENANCE MANUAL. OTHER IMPORTANT SAFETY PRECAUTIONS ARE PROVIDED THROUGHOUT THIS MANUAL.
5. Keep this manual and all literature safeguarded near or on the unit.

Model Number Description

Digits 1 to 3— Model

ACC = Air-Cooled Chiller

Digit 4 — Chiller Type

S = Single Chiller

M = Modular Chiller in Array System

Digits 5 to 7 — Nominal Capacity

010 = 10 Tons

015 = 15 Tons

020 = 20 Tons

025 = 25 Tons

030 = 30 Tons

040 = 40 Tons

050 = 50 Tons

060 = 60 Tons

070 = 70 Tons

080 = 80 Tons

Digit 8 — Unit Voltage

A = 208 V/60 Hz/3 Phase

B = 230 V/60 Hz/3 Phase

F = 460 V/60 Hz/3 Phase

G = 575 V/60 Hz/3 Phase

Digits 9 — Unit Application

A = Air-Cooled Chiller

B = Air-Cooled Chiller (Low Ambient)

C = Air-Cooled Chiller (High Ambient)

D = Heat Pump

Digit 10 - Steps of Capacity

A = Single Circuit - On/Off

Compressor

B = Single Circuit - Tandem

Compressors

C = Single Circuit - Variable Speed

Compressor

D = Circuit 1 - On/Off Compressor;

Circuit 2 - On/Off Compressor

E = Circuit 1 - Tandem Compressors;

Circuit 2 - On/Off Compressor

F = Circuit 1 - Tandem Compressors;

Circuit 2 - Tandem Compressors

G = Circuit 1 - Variable Speed;

Circuit 2 - On/Off Compressor

H = Circuit 1 - Variable Speed; Circuit

2 - Tandem Compressors

J = Circuit 1 - Variable Speed; Circuit

2 - Variable Speed

Digit 11 - Refrigerant Type

0 = R-410A

Digit 12 - Unit Efficiency

0 = Standard Efficiency

1 = High Efficiency

Digit 13 — Design Sequence

0 = Factory Assigned

Digit 14 - Evaporator Heat

Exchanger Type

0 = Brazed Plate

1 = Shell and Tube

2 = High Capacity Brazed Plate

3 = High Capacity Shell and Tube

Digit 15 — Evaporator Temp

Range

0 = Standard Cooling 40 to 65°F [4.4 to 18.3°C]

1 = Standard Cooling/Ice Making 15 to 65°F [-9.4 to 18.3°C]

Digit 16 - Evaporator Valves

0 = No Valve

1 = Constant Flow Array - Manual Balancing/Isolating Valve

2 = Variable Flow Array - Motorized Isolating valve

Digit 17 - Air-Cooled Condenser Heat Exchanger Type

0 = Microchannel Heat Exchanger (MCHE)

C = E-Coat Microchannel Heat Exchanger (MCHE)

Digit 18 - Condenser Fan Control

0 = Fixed Speed

1 = Variable Speed

Digit 19 - Condenser Water Heat Recovery

0 = No Heat Recovery

1 = Full Heat Recovery

Digit 20 — Heat Recovery Condenser Control Valves

0 = None

1 = Manual balancing/isolating valves

2 = Motorized Isolating valve

Digit 21 — Power Connection

0 = Terminal Block

A = Non-Fused Disconnect Switch

B = Fused Disconnect Switch

C = High SCCR Fuse Block

D = Distribution Panel for Array

Digit 22 - Power Feed

0 = 5 kA Rating

A = 5 kA Rating + Phase and Voltage Monitor

B = 100 kA Rating

C = 100 kA Rating + Phase and Voltage Monitor

Digit 23 - Service Options

0 = None

A = LED Lighted Control Cabinet

B = Factory Wired 115V Outlet

C = Field Wired 115V Outlet

D = LED Lighted Control Cabinet +

Factory Wired 115V Outlet

E = LED Lighted Control Cabinet +

Field Wired 115V Outlet

Digit 24 - Control Style

0 = Non-Array, Single Unit Controller

A = Master Controller w/ Single

Controller per Array

B = Supervisor Array Controller w/

Controller per Module

C = Slave Expansion Board Module

Digit 25 — Local Unit Controller Interface

0 = Keypad with Dot Pixel Display

B = 15.4" Color Touchscreen

Digit 26 — Remote BMS Interface (Digital Comm)

0 = None

2 = Lon Talk®

4 = BACnet® MS/TP

5 = BACnet IP

6 = MODBUS®

Digit 27 - Blank

0 = Blank

Digit 28 - Refrigeration Options

0 = None

1 = Active Freeze Protection All Circuits

2 = Hot Gas Bypass All Circuits

Digit 29 - Refrigeration Accessories

0 = None

A = Compressor Isolation Valves

B = Replaceable Core Filter Driers

C = Replaceable Core Filter Driers +

Compressor Isolation Valves

Digit 30 - Water Connection

0 = No Header Piping (Single Unit)

1 = Grooved Pipe Connection, Units

Connected Side-to-Side

Digit 31 - Water Side Pressure

0 = 150 psi

A = 300 psi

Digit 32 - Water Strainer(s)

0 = None

A = Chilled Water Wye Strainer

B = Chilled Water Wye Strainer with installation kit

C = Condenser Water Wye Strainer

D = Condenser Water Wye Strainer with installation kit

E = Chilled & Condenser Water Wye Strainer

Strainer

F = Chilled & Condenser Water Wye Strainer with installation kit

Digit 33 - Water Accessories

0 = Chilled Water Flow Switch

Digit 34 - Free Cooling

0 = No Free Cooling Coil

1 = With Free Cooling Coil(s)

Digit 35 — Sound Attenuator

0 = None

A = Neoprene Pads

B = Compressor Sound Blanket(s)

C = Factory Sound Enclosure Cabinet(s)

D = Both sound blanket and enclosure

E = Compressor Sound Blanket(s) + Neoprene Pads

F = Factory Sound Enclosure Cabinet(s) + Neoprene Pads

G = Both sound blanket and enclosure + Neoprene Pads

Digit 36 - Guards

0 = None

A = Wire Mesh Coil Guards

B = Base + Coil Wire Mesh Guards

C = Coil Louvers

D = Base + Coil Louvers

Digit 37 - Exterior Finish & Shipping Splits

0 = Standard Paint, Each Module Packaged Separately

B = Custom Paint, Each Module Packaged Separately

Digit 38 - Warranty

0 = Standard Warranty

A = Compressor Warranty 2-5 years

Digit 39 — Special Options

0 = None

X = With Specials

Digits 4 — Chiller Type

ACC chillers can be applied as both single and modular chillers.

S = Single Chiller - ACC chillers can be applied in standalone applications needing between 10 to 80 tons of cooling. In standalone applications, a single unit controller is selected in digit 24 and chiller headers are not required and the “no header” option can be selected in Digit 30.

M = Modular Chiller in Array System - More than one ACC modular chiller may be piped together (to form an array of chillers) for higher capacity and/or redundant chiller applications, an array controller package must be provided from the factory.

Digits 5 to 7 — Nominal Capacity

The first numbers of the model string designate nominal tons cooling. Actual capacities will vary with conditions.

010 = 10 Tons

015 = 15 Tons

020 = 20 Tons

025 = 25 Tons

030 = 30 Tons

040 = 40 Tons

050 = 50 Tons

060 = 60 Tons

070 = 70 Tons

080 = 80 Tons

**Note: The nominal capacities reflect the use of R-410A refrigerant and a standard heat exchanger.*

Digit 8 — Unit Voltage

All units have single point power blocks with grounding lugs and 12V control circuits.

A = 208 V/60 Hz/3 Phase

B = 230 V/60 Hz/3 Phase

F = 460 V/60 Hz/3 Phase

G = 575 V/60 Hz/3 Phase

Digit 9 — Unit Application

A = Air-Cooled Chiller – Standard air-cooled chiller with optional shell and tube or brazed plate evaporator.

B = Air-Cooled Chiller (Low Ambient) – Air-Cooled chiller with special considerations for operation down to -20°F

C = Air-Cooled Chiller (High Ambient) – Air-Cooled chiller with high capacity condensers for operation up to 120°F

D = Heat Pump – Chiller can produce hot or chilled water via reversing valve in refrigeration system.

Digit 10 — Steps of Capacity

A = Single Circuit - On/Off Compressor – One fixed speed compressor on one refrigeration circuit

B = Single Circuit - Tandem Compressors– Two fixed speed compressors on one refrigeration circuit

C = Single Circuit - Variable Speed Compressor – One variable speed compressor on one refrigeration circuit

D = Circuit 1 - On/Off Compressor; Circuit 2 - On/Off Compressor – One fixed speed compressor on first refrigeration circuit; One fixed speed compressor on second refrigeration circuit

E = Circuit 1 - Tandem Compressors; Circuit 2 - On/Off Compressor – Two fixed speed compressors on first refrigeration circuit; One fixed speed compressor on second refrigeration circuit

F = Circuit 1 - Tandem Compressors; Circuit 2 - Tandem Compressors – Two fixed speed compressors on first refrigeration circuit; Two fixed speed compressors on second refrigeration circuit

G = Circuit 1 - Variable Speed; Circuit 2 - On/Off Compressor– One variable speed compressor on first refrigeration circuit; One fixed speed compressor on second refrigeration circuit

H = Circuit 1 - Variable Speed; Circuit 2 - Tandem Compressors– One variable speed compressor on first refrigeration circuit, Two fixed speed compressors on second refrigeration circuit

J = Circuit 1 - Variable Speed; Circuit 2 - Variable Speed - One variable speed compressor on first refrigeration circuit; One variable speed compressor on second refrigeration circuit

Digit 11 — Refrigerant Type

0 = R-410A

Digit 12 — Efficiency

1 = Standard Efficiency

2 = High Efficiency – Additional heat transfer surface area include to increase capacity and/or reduce power consumption

Digit 13 — Design Sequence

0 = Factory Assigned

Digit 14 — Evaporator Heat Exchanger Type

0 = Brazed Plate - Brazed plate heat exchangers are one of the most efficient ways to transfer heat. They are designed to provide unparalleled performance with the lowest life-cycle cost.

1 = Shell and Tube – Shell and tube heat exchanger with grooved water connection and ¾” closed-cell rubberized insulation. (only available on single chillers)

2 = High Capacity Brazed Plate – Oversized brazed plate for 40°F leaving water applications.

3 = High Capacity Shell and Tube – Oversized shell and tube heat exchanger for glycol applications. (only available on single chillers)

6 = Remote Brazed Plate = Option 1 for remote field mounting

7 = Remote Shell and Tube = Option 2 for remote field mounting

8 = Remote High Capacity Brazed Plate = Option 3 for remote field mounting

9 = Remote High Capacity Shell and Tube = Option 4 for remote field mounting

Digit 15 — Evaporator Temperature Range

0 = Standard Cooling 40 to 65°F [4.4 to 18.3°C] – The chiller with *standard* evaporator must not be operated with a leaving water temperature of less than 42°F for a plain water application. The chiller with *high capacity* evaporator must not be operated with a leaving water temperature of less than 40°F for a plain water application.

1 = Standard Cooling/Ice Making 15 to 65°F [-6.7 to 18.3°C] - The dual roles of an ice-making chiller can substantially reduce the installed cost of the system. An ice-making chiller is NOT a conventional chiller with two different leaving-fluid temperature setpoints. An ice-making chiller operates at maximum capacity when in ice-making mode. It continues to operate at maximum capacity until the leaving-fluid temperature reaches the target setpoint. At a 10°F delta across the evaporator, this limit indicates that all of the water inside the ice storage tanks has been frozen. An external signal can be sent to the chiller to reset the chilled water setpoint back to conventional chilled water leaving fluid temperature and the chiller will return to traditional chiller operation.

Digit 16 — Evaporator Flow and Valves

0 = Standalone Unit – No Valves

2 = Constant Flow Array / Manual Balancing Isolating Valve - For a proper hydronic balance in a constant flow system, manual balancing valves are factory installed in array headers. These valves can also be used to isolate a module in an array for service or cleaning. Constant flow pumping systems utilize a staged cooling system and a constant flow water pumping system. No modules are isolated at part load. Flow from “off” chillers mixes with the flow from active chillers in creating the leaving array temperature. The load may not be less than 25% of the full load in constant flow applications.

2 = Variable Flow Primary / Motorized Isolating Valve - Variable flow systems isolate modules not needed to meet current cooling or heating capacity by isolating modules with a factory installed motorized on-off valve. Variable flow systems utilize compressor staging and motorized isolation valves with a variable flow water pumping system to modulate cooling and water flow to meet chilled water needs and save operating energy costs. Cooling capacity is modulated by staging compressors and isolating modules based on the desired leaving water temperature. Water flow control is field provided and is usually modulated with VFD controlled variable flow primary pumps based on the differential pressure across the water system. The rate of change in flow rate must not exceed 10% of design flow gpm per minute.

Digit 17 — Condenser Heat Exchanger Type

0 = Microchannel Heat Exchanger (MCHE) – Aluminum coil with aluminum fins

C = E-Coat Microchannel Heat Exchanger (MCHE) – Polymer e-coating applied to the condenser coils. Coating surpasses a 6000-hour salt spray test per ASTM B117-90, yet is only 0.8-1.2 mils this and has excellent flexibility. Option is intended for use in coastal saltwater conditions under the stress of heat, salt, sand and wind and is applicable to all corrosive environments where a polymer coating is acceptable.

Digit 18 — Condenser Fan Control

0 = Fixed Speed – Air-cooled units can operate down to 35°F by cycling condenser fans.

1 = Variable Speed – Air-cooled units can operate down to 0°F by slowing or stopping condenser fans.

Digit 19 — Condenser Heat Recovery

0 = No Heat Recovery – Chiller operates to maintain chilled water temperature. No secondary condenser heat exchanger is installed.

1 = Heat Recovery – A full capacity brazed plate condenser is provided. Instead of rejecting heat to the air-cooled condenser, heat is recovered from the brazed plate heat exchanger and condenser water and can be used in many commercial facilities for preheating incoming air, reheat in dehumidification applications, washing, showering, and other everyday usage. Such facilities include:

- Office Buildings: reheat coils, boiler preheat, general usage
- Hospitals, laundry, showers, and sterilization (often separate from other systems)
- Dormitories: laundry, showers, and general usage
- Hotels: laundry, showers, pool heat, and general usage

All of these facilities require large quantities of makeup water that must be heated.

Digit 20 — Condenser Heat Recover Control Valves

0 = None

1 = Manual Valve - For a proper hydronic balance in a constant flow system, manual balancing valves are factory installed in array headers. These valves can also be used to isolate a module in an array for service or cleaning.

2 = Motorized Head Pressure Control Valve - The integral condenser water regulating valve option is available to stabilize and maintain the refrigerant condensing pressure within the operating limits of the ACC Series modular chiller. The valve will replace one of the manual isolating valves that come standard on every chiller and can also be used to isolate the condenser from the cooling water circuit when needed.

Digit 21 — Power Connection

0 = Terminal Block - Terminal Block to land incoming power wiring.

A = Non-Fused Disconnect Switch - Non-fusible disconnect switches do not incorporate fuses into their enclosure and provide no circuit protection capability. The purpose of a non-fusible safety switch is to provide an easy means to open and close a circuit.

B = Fused Disconnect Switch - Fusible disconnect switches combine fuses with the switch in a single enclosure, providing an easy means to manually open and close the circuit while the fuses protect against overcurrent.

C = High SCCR Fuse Block - Short-circuit current ratings provide the level of fault current that a component or piece of equipment can safely withstand (based on a fire and shock hazard external to the enclosure). A 100kA SCCR can have significant impact in meeting safety and insurance requirements.

D = Distribution Panel Connection = Terminal Block; Module Power Connection = Circuit Breaker – This feature is used for the single point power options in Digit 25. Factory provided panelboard serves as a power distribution panelboard for chiller array.

Digit 22 — Power Feed

0 = Single Point Power (5 kA Rating) - This option reduces the amount of installation labor by eliminating the need to run separate power to each module in the chiller array. A single connection point is provided to power the array. With this option, the array of chillers is delivered with a separate power panel enclosure. This separate enclosure includes the electrical lug to land the incoming power cables. The cabinet has circuit breakers for each module in the array. Power wiring will be distributed to each chiller module through a wire chase that is part of each individual chiller control panel. Upon installation, the factory supplied electrical whips will be routed to each module through control panels. Conduits are also factory provided to encase the power wiring as it is routed between one chiller module and the next.

A = Single Point Power (5 kA Rating) + Phase and Voltage Monitor - This option includes the single-point power distribution panel. A factory-installed phase/power monitor designed to protect the chiller from premature failure and damage due to common voltage faults such as voltage unbalance, over/under voltage, phase loss, reversal, incorrect sequencing and rapid short cycling is included.

B = Single Point Power (100 kA Rating) - Short-circuit current ratings provide the level of fault current that a component or piece of equipment can safely withstand (based on a fire and shock hazard external to the enclosure). A 100kA SCCR can have significant impact in meeting safety and insurance requirements.

C = Single Point Power (100 kA Rating) + Phase and Voltage Monitor - This option includes the single-point power distribution panel and each unit is rate for 100ka SCCR. A factory-installed phase/power monitor designed to protect the chiller from premature failure and damage due to common voltage faults such as voltage unbalance, over/under voltage, phase loss, reversal, incorrect sequencing and rapid short cycling is included.

D = Power Feed to Each Unit (5 kA Rating) – Power is field provided to each chiller module in the array. This is beneficial in applications where redundancy or dual point power is desirable or to allow for smaller electrical feeds instead of a large single electrical feed.

E = Power Feed to Each Unit (5 kA Rating) + Phase and Voltage Monitor - This option includes field provided power and an additional factory-installed phase/power monitor designed to protect the chiller from premature failure and damage due to common voltage faults such as voltage unbalance, over/under voltage, phase loss, reversal, incorrect sequencing and rapid short cycling.

F = Power Feed to Each Unit (100 kA Rating) - Short-circuit current ratings provide the level of fault current that a component or piece of equipment can safely withstand (based on a fire and shock hazard external to the enclosure). A 100kA SCCR can have significant impact in meeting safety and insurance requirements.

G = Power Feed to Each Unit (100 kA Rating) + Phase and Voltage Monitor - This option includes field provided power and an additional factory-installed phase/power monitor designed to protect the chiller from premature failure and damage due to common voltage faults such as voltage unbalance, over/under voltage, phase loss, reversal, incorrect sequencing and rapid short cycling.

Digit 23 — Service Options

0 = None

A = LED Lighted Control Cabinet - LED lights provide bright lighting inside enclosure offer with long service life and can provide improve safety and visibility when service inside the enclosure is needed.

B = Factory Wired 115V Outlet – Factory wired electrical box with ground fault interrupter receptacle located within the control panel. The circuit is rated at 10 amps maximum and is factory wired to a step-down transformer and fuse block. The circuit is wired to the line side of the unit power block or power switch permitting use of the outlet while power to the unit is shut off. **Caution: When the power to the unit is disconnected with the factory installed unit power switch, the convenience outlet will remain live.**

C = Field Wired 115V Outlet – Field wired electrical box with ground fault interrupter receptacle, located with the control panel. Receptacle is rated for 20 amps. The outlet must be field wired to a 115 VAC power supply.

D = LED Lighted Control Cabinet + Factory Wired 115V Outlet

E = LED Lighted Control Cabinet + Field Wired 115V Outlet

Digit 24 — Control Style

0 = Non-Array, Single Unit Controller – Standalone Controller has control board with twelve 0-5vdc sensor inputs, four 5vdc digital inputs, ten 230vac 6.3amp relay outputs, four 0-10vdc analog outputs, keypad, 128 x 64 dot pixel STN monochrome graphics LCD with 2.8" diagonal viewing area, real time clock, MCS-I/O, RS-232, RS-485 and Ethernet communication ports.

A = Master Slave Controller w/ Single Controller per Array - This option allows up to six (6) ACC modular chillers to be controlled and operated. The Master-Slave Array Controller requires only a single controller for the array. This option is beneficial in replacement applications where a single larger chiller, with one controller, is replaced by modular chillers controlled with one controller.

B = Supervisory Array Controller w/ Controller per Module - This option allows up to ten (10) ACC modular chillers to be controlled and operated. The Supervisory Array Controller requires each module have an individual unit controller. This option is beneficial in applications requiring seven (7) or more modules to be controlled and in applications where chiller uptime is critical. If communication between the individual ACC modular chiller unit controller(s) and the Supervisory Array Controller is lost, or the Supervisory Array Controller fails, the individual ACC modular chillers can be shifted into manual mode to operate independent from the Supervisory Array Controller and will maintain a “manual mode” default chilled leaving water temperature set point.

C = Slave/Expansion Board – Slave, or secondary, modules in the array have expansion boards to communicate inputs from the given module to the Master controller. The Master-Slave Array Controller requires only a single controller for the array. This option is beneficial in replacement applications where a single larger chiller, with one controller, is replaced by modular chillers controlled with one controller.

Digit 25 — Local Unit Controller Interface

0 = Keypad with Dot Pixel Display - keypad, 128 x 64 dot pixel STN monochrome graphics LCD with 2.8" diagonal viewing area

B = 15.4-in. Color Touchscreen - Information and graphics are shown on high resolution (1280x800) LCD display with LED back lighting. The high-resolution screen makes it easy for the user to manage complex installations without losing the overall view or requiring a separate laptop. Pages can be navigated in a fast and straightforward manner.

Digit 26 — Remote BMS Interface (Digital Comm)

0 = None

2 = Lon Talk®

4 = BACnet® MS/TP

5 = BACnet® IP

6 = MODBUS®

Digit 27 — Blank

0 = Blank

Digit 28 — Refrigeration Options

0 = None

1 = Active Freeze Protection (All Circuits) – Active freeze protection is a suction pressure-based freeze protection. Active Freeze Protection is standard on all ACC Series chillers. The chiller's unit controller continually monitors the saturated suction pressure and will open (energize) the Active Freeze Protection solenoid if the suction pressure falls to approximately 101 psig (32°F). The solenoid closes (de-energizes) when the pressure climbs to approximately 105 psig (34°F) and the freezing potential no longer exists.

2 = Hot Gas Bypass (All Circuits) - Hot gas bypass can stabilize the system balance point by diverting hot, high- pressure refrigerant vapor from the discharge line directly to the low-pressure side of the system. This tactic keeps the compressor more fully loaded while the evaporator satisfies the part-load condition. The Jetson Active Freeze Protection can be configured to function as Hot Gas Bypass by configuring the controller to monitor both the leaving water temperature and the suction temperature. In Hot Gas Bypass operating mode, the Active Freeze Protection provides an additional step of capacity.

Digit 29 — Refrigeration Accessories

0 = Moisture Indicating Sight Glass - The sight glass shows if the liquid line has a full line of liquid or if it has bubbles which shows it's a liquid/vapor mix. It should not be used to determine proper charge. The moisture indicator shows if the system is dry or if it has harmful moisture content.

A = Moisture Indicating Sight Glass + Compressor Isolation Valves – In addition to the Moisture Indicating Sight Glass, ball type Compressor Isolation Valves are mounted on the cooling circuit discharge and liquid lines permitting isolation of the compressors and filter driers for service or replacement. The valves are located close to the compressors. The valve works through a quarter turn from open to closed. Teflon seals and gaskets are used with a nylon cap gasket to prevent accidental loss. This option reduces the amount of refrigerant that must be recovered during compressor service or replacement.

B = Moisture Indicating Sight Glass + Replaceable Core Filter Driers - In addition to the Moisture Indicating Sight Glass, Replaceable Core Filter Driers allow for easy changeout of the filter-drier element.

C = Moisture Indicating Sight Glass + Replaceable Core Filter Driers + Compressor Isolation Valves

Digit 30 — Water Connection

0 = No Header Piping (Heat Exchangers Only) used in single chiller applications

1 = Grooved Pipe Connection, Units Connected Side-to-Side – Chillers are set alongside other chillers along the long dimension. A common header is connected between chillers on the short dimension.



Digit 31 — Water Side Pressure

0 = 150 psi

A = 300 psi

Digit 32 — Water Strainer(s)

0 = None

A = Chilled Water Flow Wye Strainer – Factory provided, field installed wye strainer can be placed in a horizontal or vertical pipeline as long as the screen is in a downward position. Straining is accomplished via a 20-mesh lined straining element.

B = Chilled Water Wye Strainer with Installation Kit - Wye strainer installation kits provide piping transitions need to easily attach the wye strainer to the chiller.

C = Condenser Water Flow Wye Strainer – Factory provided, field installed wye strainer can be placed in a horizontal or vertical pipeline as long as the screen is in a downward position. Straining is accomplished via a 20-mesh lined straining element.

D = Condenser Water Wye Strainer with Installation Kit - Wye strainer installation kits provide the piping transitions needed to easily attach the wye strainer to the chiller.

E = Chilled and Condenser Water Nominal Flow Wye Strainer

F = Chilled and Condenser Water Wye Strainer with Installation Kit

Digit 33 — Water Accessories

0 = Chilled Water Flow Switch - An evaporator flow-proving device is required for all ACC Series chiller applications. A paddle style liquid flow switch is available with a NEMA Type 4X enclosure for field-installation.

Digit 34 — Free Cooling

0 = None

1 = With Free Cooling - Free cooling is an economical method of using low external air temperatures to assist in chilling water. When outdoor temperatures are lower relative to indoor temperatures, this system utilizes the cool outdoor air as a free cooling source.

Digit 35 — Sound Attenuator

0 = None

A = Neoprene Pads - In applications that are sensitive to noise and vibration, optional neoprene isolator pads can be provided for load bearing points on ACC chillers.

B = Compressor Sound Blankets - Factory installed Compressor Sound Blankets provide insulated sound covers on each compressor. These blankets dampen compressor generated sound. The blankets can be used alone or in combination with a sound cabinet.

C = Factory Sound Enclosure Cabinet - The sound enclosure is a factory installed option. The panels completely encase the chiller module. The panels, lined with sound absorbing insulation, can be removed for access in case of service and provide a streamlined appearance to the product while in place.

D = Compressor Sound Blankets + Factory Sound Enclosure Cabinet

E = Compressor Sound Blanket(s) + Neoprene Pads

F = Factory Sound Enclosure Cabinet(s) + Neoprene Pads

G = Compressor Sound Blankets + Factory Sound Enclosure Cabinet + Neoprene Pads

Digit 36 — Guards

0 = None

A = Wire Mesh Coil Guards - Optional factory-installed, vinyl-coated, welded-wire guards provide protection for the condenser coils.

B = Base + Coil Wire Mesh Guards - Optional factory-installed, vinyl-coated, welded-wire guards provide protection for the condenser coils and lower portion of the unit.

B = Coil Louvers - Optional factory-installed, louvered panels provide protection for the condenser coils.

C = Base + Coil Louvers - Optional factory-installed, louvered panels provide protection for the condenser coils and lower portion of the unit.

Digit 37 — Exterior Finish and Shipping Splits

0 = Standard Paint, Each Module Packaged Separately – Standard Jetson paint process uses primer wash then spray coated with a two-part polyurethane exterior paint.

B = Custom Paint, Each Module Packaged Separately – Custom colors are available for applications requiring ACC Series chiller to match existing color palettes.

Digit 38 — Warranty

0 = Standard Warranty – Warranty period is a period of twelve (12) months from date of start-up or eighteen (18) months from date of original shipment, whichever may occur first.

0 = Compressor Warranty (2-5 year) – Additional parts only warranty covering compressor(s) through 5 years from date of shipment.

Digit 39 — Special Options

0 = None

X = With Specials

General Information

Jetson ACC air-cooled chillers are complete self-contained liquid chilling units. They are factory assembled, wired, charged and run tested. Primary pumping package is available as an optional feature.

 WARNING QUALIFIED INSTALLER
Improper installation, adjustment, alteration, service or maintenance can cause property damage, personal injury or loss of life. Startup and service must be performed by a Factory Trained Service Technician.

System should be sized in accordance with the American Society of Heating, Refrigeration and Air Conditioning Engineers Handbook.

Installation of ACC chillers units must conform to the ICC standards of the International Mechanical Code, the International Building Code, and local building, plumbing and waste water codes. All appliances must be electrically grounded in accordance with local codes, or in the absence of local codes, the current National Electric Code, ANSI/NFPA 70 or the current Canadian Electrical Code CSA C22.1.

 CAUTION
The Clean Air Act of 1990 bans the intentional venting of refrigerant as of July 1, 1992. Approved methods of recovery, recycling, or reclaiming must be followed.

 WARNING
Coils and sheet metal surfaces present sharp edges and care must be taken when working with equipment.

 WARNING
Failure to observe the following instructions will result in premature failure of your system and possible voiding of the warranty.

Receiving Unit

When received, the unit should be checked for damage that might have occurred in transit. If damage is found it should be noted on the carrier's freight bill. A request for inspection by carrier's agent should be made in writing at once. Nameplate should be checked to ensure the correct model sizes and voltages have been received to match the job requirements.

If repairs must be made to damaged goods, then the factory should be notified before any repair action is taken in order to protect the warranty. Certain equipment alteration, repair, and manipulation of equipment without the manufacturer's consent may void the product warranty. Contact Jetson shipping department for assistance with handling damaged goods, repairs, and freight claims: (903) 758-2900.

NOTE: Upon receipt check shipment for items that ship loose, such as sensors. Consult order and shipment documentation to identify potential loose-shipped items. Loose-shipped items may have been placed inside the unit cabinet for security. Installers and owners should secure all doors with locks or nuts and bolts to prevent unauthorized access.

Storage

If installation will not occur immediately following delivery, store equipment in a dry protected area away from construction traffic and in the proper orientation as marked on the packaging with all internal packaging in place. Secure all loose-shipped items.

Failure to observe the following instructions may result in premature failure of your system, and possible voiding of the warranty.

 CAUTION CRANKCASE HEATER OPERATION Units are equipped with compressor crankcase heaters, which should be energized at least 24 hours prior to cooling operation, to clear any liquid refrigerant from the compressors

Never turn off the main power supply to the unit, except for complete shutdown. When power is cut off from the unit, any compressors using crankcase heaters cannot prevent refrigerant migration. This means the compressor will cool down, and liquid refrigerant may accumulate in the compressor. The compressor is designed to pump refrigerant gas and damage may occur when power is restored if liquid enters the compressor.

 CAUTION Rotation must be checked on all MOTORS AND COMPRESSORS of three phase units. All motors, to include and not be limited to pump motors and condenser fan motors, should all be checked by a qualified service technician at startup and any wiring alteration should only be made at the unit power connection.

Before unit operation, the main power switch must be turned on for at least 24 hours for units with compressor crankcase heaters. This will give the crankcase heater time to clear any liquid accumulation out of the compressor before it is required to run.

 CAUTION Scroll compressors are directional and will be damaged by operation in the wrong direction. Low pressure switches on compressors have been disconnected after factory testing. Rotation should be checked by a qualified service technician at startup using suction and discharge pressure gauges and any wiring alteration should only be made at the unit power connection.
--

Wiring Diagrams

A unit specific wiring diagrams in point-to-point form is laminated in plastic and located inside the control compartment door.



CAUTION

FIELD WIRED CONNECTIONS

Some units may require field wired connections. Refer to the wiring diagrams contained within the unit to identify any components or controls requiring additional wiring in the field before placing the unit into service. All additional field wiring should be performed by a trained service technician.

General Maintenance

When the initial startup is made and on a periodic schedule during operation, it is necessary to perform routine service checks on the performance of the condensing unit. This includes reading and recording suction pressures and checking for normal subcooling and superheat.

Primary Pumping Package

Primary pumping uses a single pump to move water or glycol through the evaporator and back to the building. This pumping package provides the necessary flow of water to the system. The pump is activated whenever the chiller is given a run signal.

Water enters the unit through the return water piping, and then the water flows through a suction guide with strainer. Some units will not include a suction guide if there is enough straight piping before the pump. The end of the suction guide is removable for strainer access. The strainer assembly is composed of two parts, the operational strainer, and the startup strainer, (located inside the operational strainer) which is to be removed 24 hours after startup.

The pump is installed after the strainer, and before a combination valve (Flo-Trex). This

combination valve acts as isolation valve, check valve, and flow balancing valve. The shell and tube or brazed plate evaporator is placed after the combination valve in the water circuit with a differential pressure switch installed across its inlet and outlet. This pressure switch closes when the differential pressure increases above the setpoint, which should be set 1-2 psig below the pressure drop across the heat exchanger at design flow rate. The closing differential pressure switch signals the control system to indicate flow through the heat exchanger and allow cooling to activate as required to maintain the setpoint. The water exiting the shell and tube or brazed plate evaporator, leaves the unit through the water out connection.

Glycol

Glycol units require a glycol feeder field installed to replace fluid that is lost in the system. Water should not be directly added to glycol applications as this would dilute the glycol concentration and thereby increase the freezing temperature of the fluid.

Compression Tank

As the water temperature in the system increases, the volume that water displaces increases. In order to compensate for these forces, a field provided pre-pressurized diaphragm compression tank that is preset for 12 psig is recommended.

Pressure Relief Valve

Required pressure relief valve is installed on shell and tube evaporator.

Dual Pumps

When redundant pumping is required, a factory installed dualArm pump may be ordered, depending on unit size and options. A dualArm pump is a pump with two independent motors and pumps in a single

casing. This pump has a swing split-flapper valve in the discharge port to prevent liquid recirculation when only one pump is operating. Isolation valves in the casing allow one pump to be isolated and removed for service while the other pump is still operating.

The controls package will activate the pump when the unit is given a run command. If the controls do not recognize flow in 60 seconds, the second pump will be activated and an alarm signal will be generated. If the second pump does not activate, the cooling will be locked out.

Pipe Insulation

The evaporator in the ACC chiller is factory insulated. The water piping, pumps, and other components on units with pumping packages are not insulated at the factory. Insulation should be installed on the water piping after the system has been checked for leaks.

Installation

Forklifting the unit

Units can be lifted using a forklift. Lifting the unit with forks perpendicular to the long dimension may use forks 48" in length. Lifting of units with forks parallel to the unit's long dimension must have forks 72" in length or the forks must have 72" fork extensions. Standard units can be lifted from all sides except the evaporator end. Forks must be perpendicular to the unit and they must be in far enough that the back of the forks are no more than 6" away from the edge of the unit.

Lifting the Unit

Do not lift unit from above unless spreader bars are used. Each module should be lifted

using lift straps threaded through the steel base cutouts and a spreader bar.

If cables or chains are used to hoist the unit, they must be the same length. Care should be taken to prevent damage to the cabinet, coils, and condenser fans. Before lifting unit, be sure that all shipping material has been removed from unit. Secure hooks and cables at all lifting points / lugs provided on the unit.

Hoist unit to a point directly above the curb or concrete pad. Be sure that the gasket material has been applied to curb.

Carefully lower and align the unit with utility and duct openings. Lower the unit until the unit skirt fits around the curb. Make sure the unit is level and properly seated on the curb or pad.

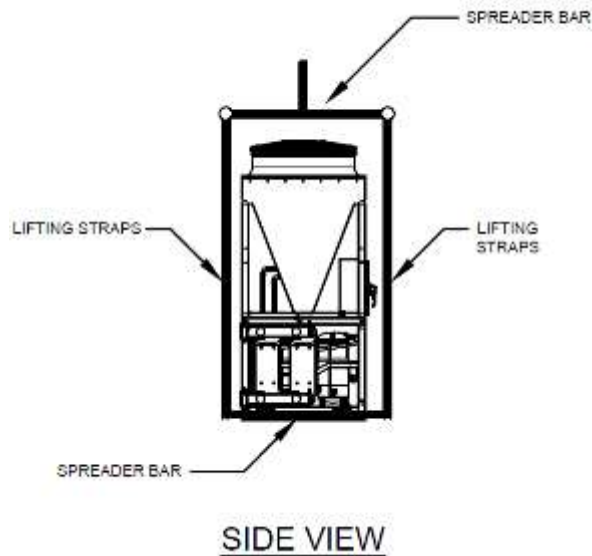
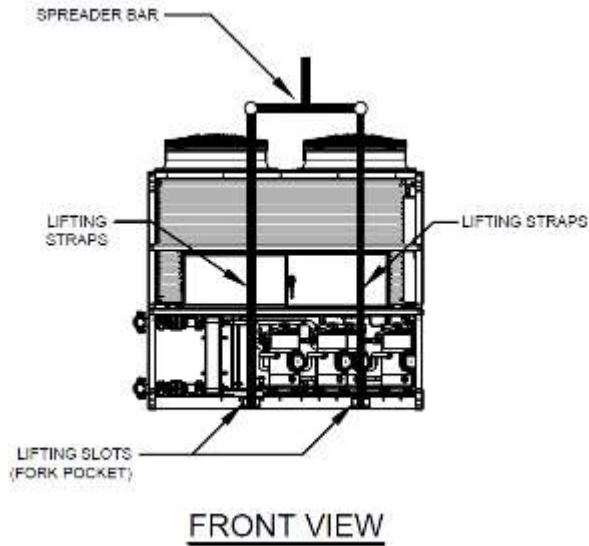

Figure 1 Rigging and forklift pockets



WARNING

HEAVY OBJECTS

Failure to follow instructions or properly lift unit could result in unit dropping and possibly crushing operator/technician which could result in death or serious injury, and equipment or property-only damage. Ensure that all the lifting equipment used is properly rated for the weight of the unit being lifted. Each of the cables (chains or slings), hooks, and shackles used to lift the unit must be capable of supporting the entire weight of the unit. Lifting cables (chains or slings) may not be of the same length. Adjust as necessary for even unit lift.



WARNING

IMPROPER UNIT LIFT

Failure to properly lift unit could result in unit dropping and possibly crushing operator/technician which could result in death or serious injury, and equipment or property-only damage. Test lift unit approximately 2 to 4 inches to verify proper center of gravity lift point. To avoid dropping of unit, reposition lifting point if unit is not level.



CAUTION

IMPROPER UNIT LIFT

If no, or improperly sized, spreader bar is used, damage to the unit may occur.

Locating the Unit

The ACC chiller is designed for outdoor applications and mounting at ground level or on a rooftop. It must be placed on a level and

solid foundation that has been prepared to support its weight. When installed at ground level, a one-piece concrete slab should be used with footings that extend below the frost line. With ground level installation, care must be taken to protect the coil from damage due to vandalism or other causes. ACC chillers are available with factory installed condenser coil guards.

The placement relative to the building air intakes and other structures must be carefully selected. Airflow to and from the chiller must not be restricted to prevent a decrease in performance and efficiency.

The installation position must provide at least sufficient clearance for proper airflow to the condenser coils. See Table 1 for individual unit clearances. When units are mounted adjacent to each other, the minimum clearance required between the units is 6 feet.

Table 1 - Service Clearances

Location	Clearance
Front - (Facing Controls)	42"
Back Side	24"
Left	48"
Right	48"
Top	Unobstructed

Units should not be installed in an enclosure or pit that is deeper than the height of the unit. When recessed installation is necessary, the clearance to maintain proper airflow is at least 6 feet.

ACC chillers have a vertical air discharge. There must be no obstruction above the

equipment. Do not place the unit under an overhang.

For proper unit operation, the immediate area around condenser must remain free of debris that may be drawn in and obstruct airflow in the condensing section.

Consideration must be given to obstruction caused by snow accumulation when placing the unit.

Typical Water Piping

All building water piping must be flushed prior to making final connections to the chiller. To reduce heat loss and prevent condensation, insulation should be applied. Expansion tanks are also usually required so that chilled water volume changes can be accommodated. A volume buffer tank should be located in the return water piping. *Figure 2 Expansion Tank Usage* illustrates a proper volume buffer tank usage.

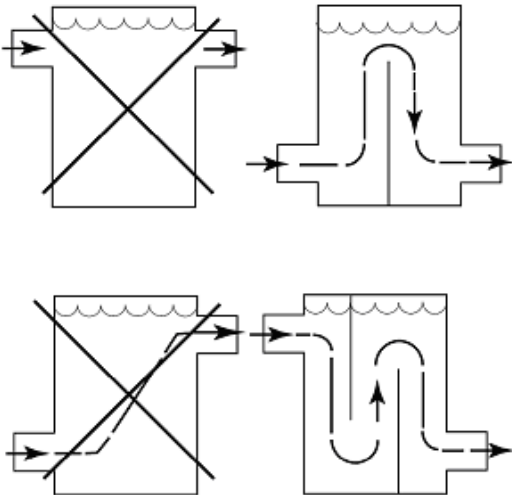

Figure 2 Expansion Tank Usage

Variable Flow

ACC Series chillers can be applied in variable flow applications where the flow is varied and

controlled by others. The flow being delivered to the chiller must not go outside the stated minimum and maximum flow rates in the product catalog. Also, the chilled water system volume should be calculated using the highest evaporator flow rate to be delivered to the chiller, and the rate of change in flow rate must not exceed 10% of design flow gpm per minute.

In ACC Series chiller arrays, the chillers are piped with a common header. Notice in *Figure 3. Variable Flow with Parallel Pumps* this common header arrangement allows the ability to operate the system in several ways depending on the load and/or current situation. For instance, the system can be operated with two pumps and one chiller so that flow out into the system can be increased, without needing to stage on an additional chiller.

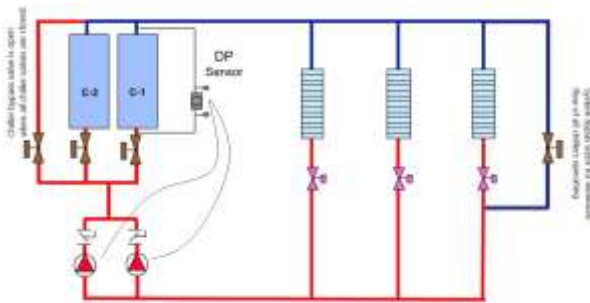

Figure 3. Variable Flow with Parallel Pumps
This configuration also allows flexible redundancy with commonly headered pumps and chillers. If a pump goes down, the remaining pump can serve one or both chillers and still meet the required load. If a chiller needs service or is turned off, the system can compensate for some of the loss in capacity by increasing flow through the remaining chiller while operating both pumps. However, the flow being delivered to any chiller must not go outside the stated minimum and maximum flow rates.

By maintaining the flow between the minimum and maximum flow rates, the chiller is able to provide proper heat transfer and stable operation at lower flows and avoid eroding the pipes at higher flows.

Variable Flow Bypass Valves

A bypass valve is required at the chillers and the load (air handlers, terminal devices, etc.) in systems with variable flow pumping. The bypass must be piped so the temperature and differential pressure sensors are always sensing active flow.

Load Bypass Valve

If a single load side bypass valve is used, it should be sized to bypass the minimum water flow at *maximum* chiller load. This size is required because there can be a lag between the load measured at the system load and at the ACC Series chiller bank. This lag can create different flow requirements at the load versus the chiller(s).

An example of this lag is when a building becomes occupied in the morning and the chillers are in a pull-down situation. The air handlers serving the occupied space reach the desired occupied temperature and simultaneously drive their control valves closed. At the same time, the chillers are still in a pull-down mode and running at full capacity to reach the desired leaving water temperature. As a result, the chiller(s) require more flow than the rest of the system until the chiller controls unload the chiller to match the new system load condition. Without a system bypass valve, the system pump(s) will either provide too much flow to the load (air handlers, terminal devices, etc.) or not enough flow the chiller array. The bypass valve also ensures that there is an adequate minimum

flow thru the pump if all the valves in the load system are closed, otherwise the pumps can deadhead.

Bypass valves at the end of the loop/system, as shown in *Figure 4. Example Load Bypass Valve Arrangements*, promotes keeping the overall active loop volume high. Some systems may not allow for an end-of-loop bypass. In these situations, the bypass valve may be installed closer to the chiller, provided the minimum system volume equaling a minimum of a 2-3 minute loop time is maintained to ensure proper operation. (See section on “Loop Time” in this catalog for more information.)

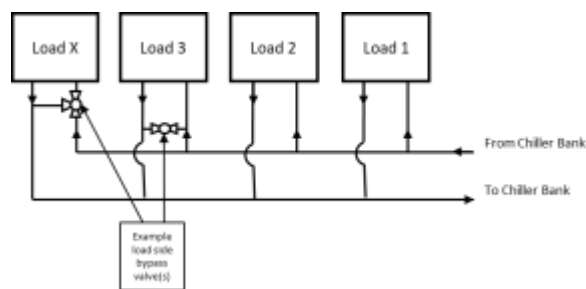

Figure 4. Example Load Bypass Valve Arrangements

External Chiller Array Bypass Valve

A bypass valve for the chiller array is required so that when the chiller array has reached the desired leaving water temperature, and the motorized valves for each module have closed, system flow remains through the external chiller array bypass valve. The chiller bypass should be sized for the minimum flow of one chiller module or the minimum flow of the system’s pumping system, whichever is greater. This bypass is only required to be open when all motorized valves in the chiller array are closed. After the first module is active and the motorized valves are the open, the external chiller array

bypass valve can be closed because the active module now provides the water flow path.

Avoidance of Short Water Loops

Adequate water volume is an important system design parameter because it provides for stable chilled water temperature control and helps limit unacceptable short cycling of chiller compressors.

The chiller’s temperature control sensor is located in the supply (outlet) water connection or pipe. This location allows the building to act as a buffer to slow the rate of change of the system water temperature. If there is not sufficient water volume in the system to provide an adequate buffer, temperature control can suffer, resulting in erratic system operation and excessive compressor cycling.

Typically, a three-minute water loop circulation time is sufficient to prevent short water loop issues. Therefore, as a guideline, ensure the volume of water in the chilled water loop is greater than or equal to three times the evaporator flow rate. For systems with a rapidly changing load profile the volume should be increased.

If the installed system volume does not meet the above recommendations, the following items should be given careful consideration to increase the volume of water in the system and, therefore, reduce the rate of change of the return water temperature.

- A volume buffer tank located in the return water piping.
- Larger system supply and return header piping (which also reduces system pressure drop and pump energy use).

Minimum Water Volume for a Process Application

If a chiller is attached to an on/off load such as a process load, it may be difficult for the controller to respond quickly enough to the very rapid change in return solution temperature if the system has only the minimum water volume recommended. Such systems may cause chiller low temperature safety trips or in the extreme case evaporator freezing. In this case, it may be necessary to add or increase the size of the mixing tank in the return line.

Water Connection

Connect the chiller supply and return water lines. The water connections are schedule 40 grooved black pipe. The maximum operating pressure for the ACC chiller is 150 psi.

Make sure water piping connections to the evaporator are isolated, and confirm that all piping to unit is supported independently to prevent any load being transferred to the unit. Use unions, flanges or grooved lock

type fittings to facilitate service procedures. Use a pipe sealant such as Teflon® tape on all threaded water connections. Use vibration eliminators to prevent transmitting vibrations through the water lines. Construct and install piping in accordance with all local, state and national codes.

Supply and insulate the chilled water piping as required, to prevent sweating and minimize heat gain under normal operating conditions. Chilled water piping must rise above the chiller to ensure the evaporator is full of water and void of air at all times. Install thermometers in the lines to monitor evaporator entering and leaving water temperatures.

ACC modular chillers have manual balancing ball-valves in the entering water lines. They may be used to establish a balanced water flow. Both the entering and leaving water lines have valves that can be used to shutoff/isolate the evaporator for service.

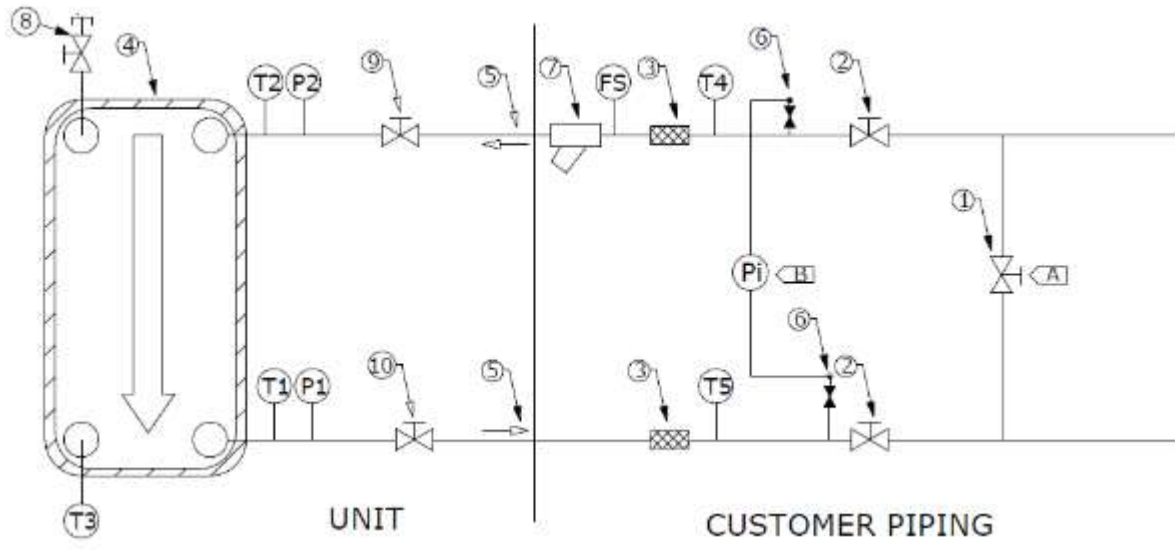

Chilled water piping components

Item	Description	Item	Description
1	Bypass Valve	A	Isolator Unit for initial water loop cleaning
2	Isolation Valves	B(a)	Arrangement for Measuring Differential Pressure
3	Vibration Eliminators	FS(b)	Water Flow Switch
4	Evaporator Heat Exchanger	Pi	Pressure Gauge
5	Inlet & Outlet Chilled Water Lines	T1	Evaporator Outlet Temperature Sensor
6	Valves for Pressure Measurement	T2	Evaporator Inlet Temperature Sensor
7(c)	Strainer with 20 Mesh Screen	T3	Evaporator Core Temperature Sensor
8	Evaporator Manual Air Vent Valve w/ Plug	T4	Chiller Inlet Temperature Gauge
9	Evaporator Manual Ball Valve	T5	Chiller Outlet Temperature Gauge
10	Evaporator Manual Ball Valve (Motorized On/Off Valve, optional)	P1	Evaporator Outlet Pressure Sensor
		P2	Evaporator Inlet Pressure Sensor

(a) Must account for water head difference when calculating total unit pressure differential.
 (b) Chilled water flow-proving device is required.
 (c) Strainer is factory supplied and field installed.

! WARNING
 The chiller must only be operated only with adequate volume and type of fluid flowing through the evaporators.

Mounting Isolation

For roof mounted applications or anytime vibration transmission is a factor, full perimeter vibration isolators may be used.

Access Doors

Lockable access doors are provided to the control compartment.

Electrical

The single point electrical power connections are made in the electrical control compartment. The microprocessor control furnished with the unit is supplied with its own power supply factory wired to the main power of the chiller.

Check the unit nameplate voltage to make sure it agrees with the power supply. Connect power to the unit according to the wiring diagram provided with the unit.

Table 2 - Nameplate Voltage Markings

Voltage Feature	Nameplate Voltage Marking	Min/Max VAC
208V/3Φ/60Hz	208	197/228
230V/3Φ/60Hz	230	197/252
460V/3Φ/60Hz	460	456/504
575V/3Φ/60Hz	575	570/630

Note: Units are factory wired for 208V, 230V, 460V, or 575V. The transformer configuration must be checked by a qualified technician prior to startup.

CAUTION

3-PHASE ROTATION

Rotation must be checked on all **MOTORS AND COMPRESSORS** of three phase units. Condenser fan motors should be checked by a qualified service technician at startup and any wiring alteration should only be made at the unit power connection. Variable frequency drives are programmed to automatically rotate the fan in the correct rotation. Do not rely on fans with variable frequency drives for compressor rotation.

Size supply conductors based on the unit MCA rating. Supply conductors must be rated a minimum of 167°F (75°C).

Route power and control wiring, separately, through the utility entry. Do not run power and signal wires in the same conduit.

Protect the branch circuit in accordance with code requirements. The unit must be electrically grounded in accordance with local codes, or in the absence of local codes, the current National Electric Code, ANSI/NFPA 70 or the current Canadian Electrical Code CSA C22.1.

Power wiring is to the unit terminal block or main disconnect. All wiring beyond this point has been done by the manufacturer and cannot be modified without effecting the unit's agency/safety certification.

Three phase voltage imbalance will cause motor overheating and premature failure. The maximum allowable imbalance is 5%.

Voltage imbalance is defined as 100 times the maximum deviation from the average voltage divided by the average voltage.

Example:
 $(218V+237V+235V)/3 = 230V$, then
 $100*(230V-218V)/230V = 5.2\%$, which exceeds the allowable imbalance.

Check voltage imbalance at the unit disconnect switch and at the compressor terminal. Contact your local power company for line voltage corrections.

Sample Electrical Diagram

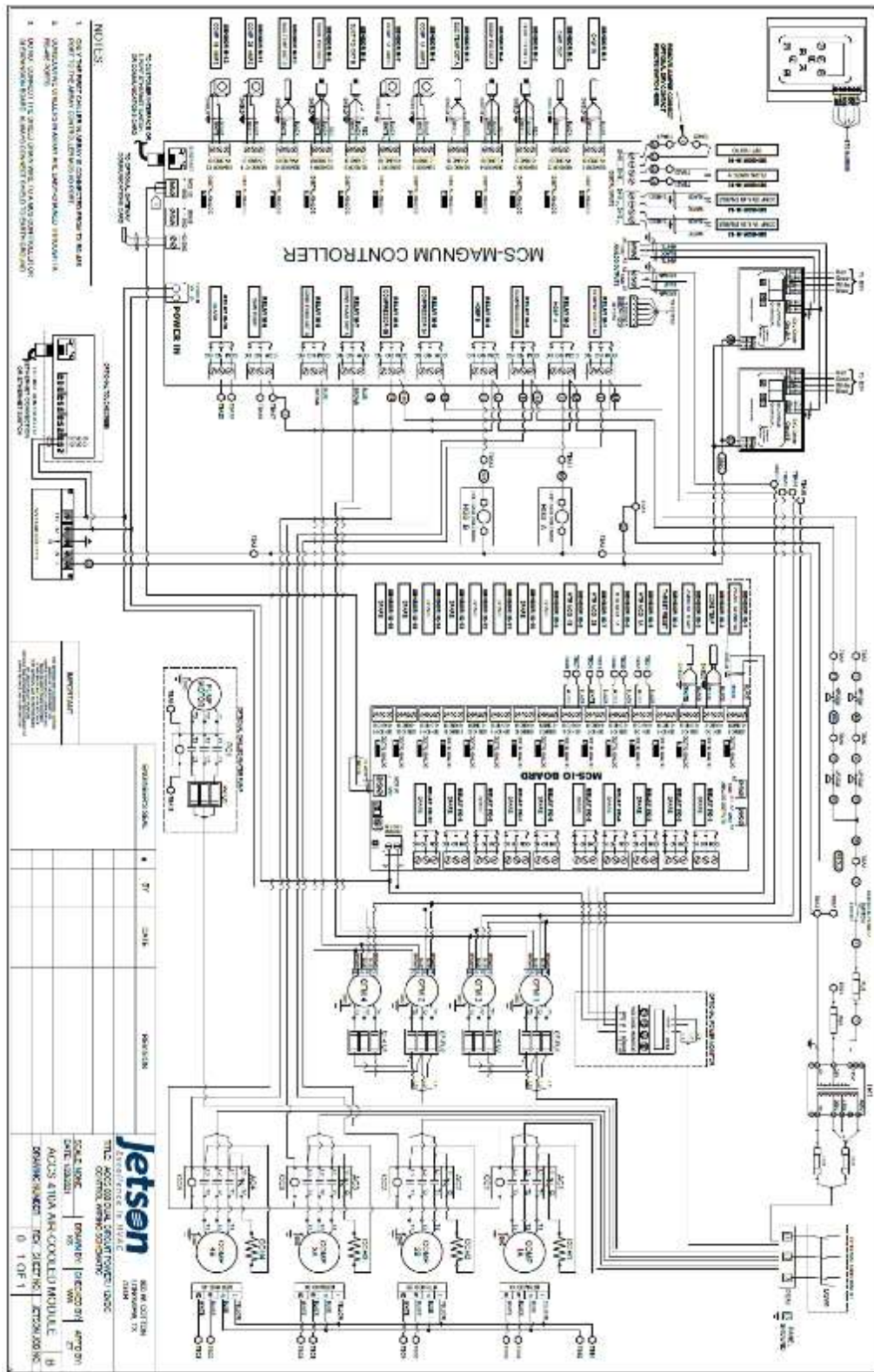
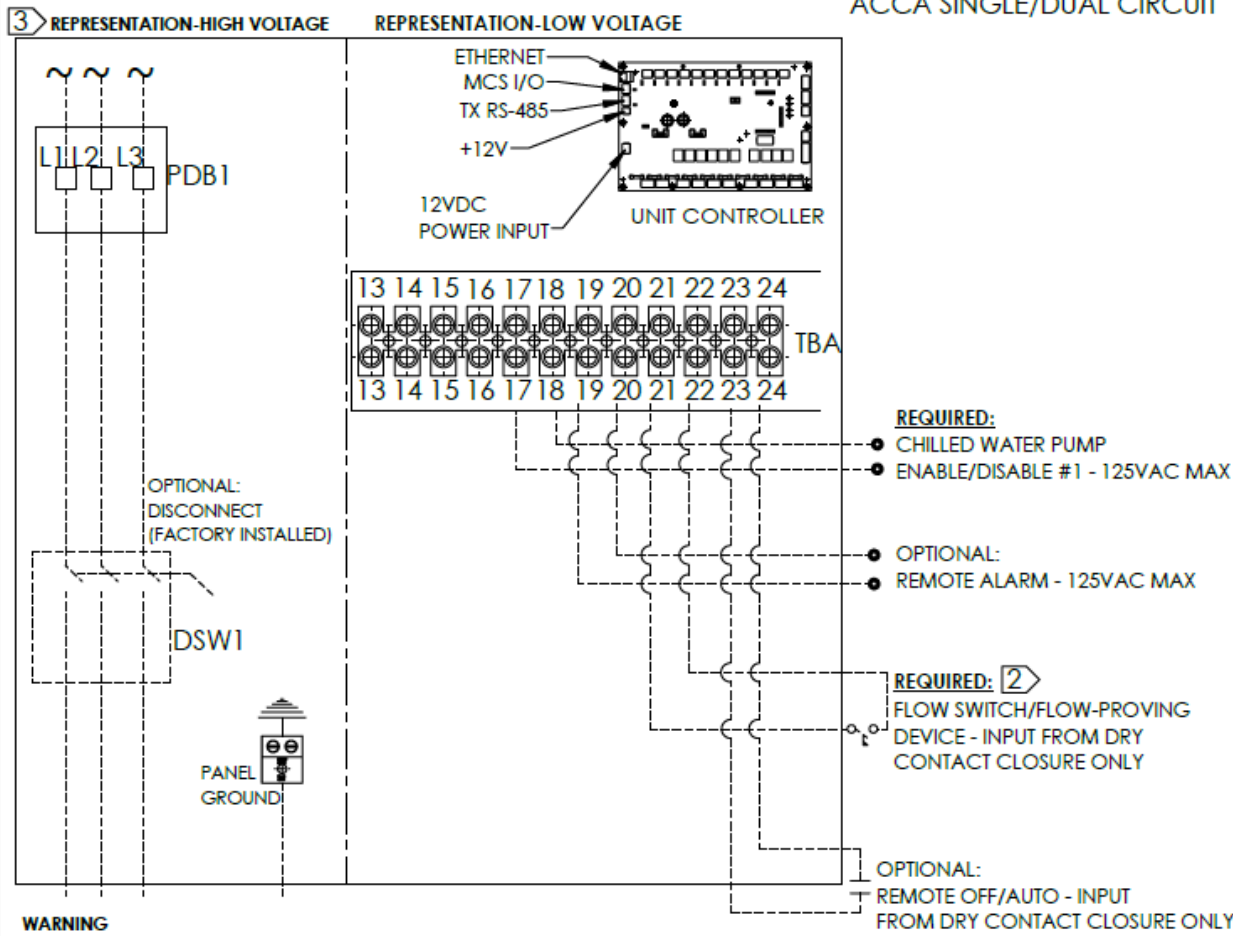

Figure 5. Sample Electrical Diagram. Contact Factory for specific wiring diagram needs.

FIELD WIRING-
ACCA SINGLE/DUAL CIRCUIT



WARNING
HAZARDOUS VOLTAGE!
DISCONNECT ALL ELECTRICAL POWER INCLUDING REMOTE DISCONNECTS BEFORE SERVICING UNIT. FOLLOW PROPER LOCKOUT/TAGOUT PROCEDURES TO ENSURE POWER CANNOT BE INADVERTENTLY ENERGIZED. FAILURE TO DO SO CAN CAUSE DEATH OR SERIOUS INJURY.

CAUTION
USE COPPER CONDUCTORS ONLY!
UNIT TERMINALS ARE NOT DESIGNED TO ACCEPT OTHER CONDUCTOR TYPES. FAILURE TO USE COPPER CONDUCTORS MAY CAUSE EQUIPMENT DAMAGE.

CAUTION
DO NOT ENERGIZE THE UNIT UNTIL CHECK-OUT AND STARTUP PROCEDURES HAVE BEEN COMPLETED

- NOTES:
1. ALL CUSTOMER CONTROL-CIRCUIT WIRING MUST HAVE A MINIMUM RATING OF 150V.
 2. **(REQUIRED)** FACTORY SUPPLIED OR APPROVED ALTERNATE FIELD INSTALLED FLOW PROVING DEVICE CONNECTION
 3. LINE VOLTAGE OPTIONS: SINGLE OR DUAL SOURCE POWER MAY BE SPECIFIED. DRAWING COVERS SINGLE SOURCE POWER ONLY. ALL FIELD WIRING MUST BE IN ACCORDANCE WITH NATIONAL ELECTRIC CODE AND STATE & LOCAL REQUIREMENTS.

PROPRIETARY AND CONFIDENTIAL
THE INFORMATION CONTAINED IN THIS DRAWING IS THE SOLE PROPERTY OF JETSON HVAC. ANY REPRODUCTION IN PART OR AS A WHOLE WITHOUT THE WRITTEN PERMISSION OF JETSON HVAC IS PROHIBITED.

	NAME	DATE
DRAWN	JF	07/29/2020
CHECKED		
ENG APPR.		
MFG APPR.		
G.A.		

COMMENTS:

DO NOT SCALE DRAWING



www.JetsonHVAC.com

TITLE:
FIELD WIRING FOR ACCA DUAL CIRCUIT STANDALONE UNIT

SIZE	DWG. NO.	REV
A	ACCA-ELEC-FWDG	0
SCALE: 1:5	WEIGHT:	SHEET 1 OF 1

 **WARNING**
ELECTRIC SHOCK

Electric shock hazard. Before attempting to perform any installation, service, or maintenance, shut off all electrical power to the unit at the disconnect switches. Unit may have multiple power supplies. Failure to disconnect power could result in dangerous operation, serious injury, death or property damage.

Note: Startup technician must check motor amperage to ensure that the amperage listed on the motor nameplate is not exceeded.

 **CAUTION**
SEALING ELECTRICAL ENTRIES

Installing Contractor is responsible for proper sealing of the electrical entries into the unit. Failure to seal the entries may result in damage to the unit and property.

 **WARNING**
CONVENIENCE OUTLETS AND SERVICE LIGHTS

Convenience outlet and service light circuits are wired to the incoming power side of the disconnect. These circuits will remain powered even when unit disconnect is off.

1. Verify that electrical power is available to the unit.
2. Verify that any remote stop/start device connected to the chiller controller is requesting the chiller to start.
3. Verify that liquid flow is present through the chiller from the building.
4. There should be a building load of at least 25% of the chiller capacity in order to properly check operation.
5. Using controller set the leaving water temperature setpoint.
6. Use the general check list at the top of the startup form to make a last check that all the components are in place, water flow is present, and the power supply is energized.
7. Cycle through all the compressors to confirm that all are operating within tolerance.
8. While performing the check, use the startup form to record observations of amps and refrigerant pressures.
9. When all is running properly, use controller to place the controller in the run mode and observe the system until it reaches a steady state of operation.

Startup

Before startup of the chiller make sure that the following items have been checked.

CAUTION

Rotation must be checked on all MOTORS AND COMPRESSORS of three phase units. All motors, to include and not be limited to pump motors and condenser fan motors, should all be checked by a qualified service technician at startup and any wiring alteration should only be made at the unit power connection.

CAUTION

Before completing installation, a complete operating cycle should be observed to verify that all components are functioning properly.

Maintenance

General

Qualified technicians must perform routine service checks and maintenance. This includes reading and recording the condensing and suction pressures and checking for normal sub-cooling and superheat.

Compressors

The scroll compressors are fully hermetic and require no maintenance except keeping the shell clean.

Refrigerant Filter Driers

Each refrigerant circuit contains a filter drier. Replacement is recommended when there is excessive pressure drop across the assembly or moisture is indicated in a liquid line sight glass.

Table 3- Max Filter Drier Pressure Drops

Circuit Loading	Max. Pressure Drop
100%	10 psig
50%	5 psig

Evaporator

The evaporators are direct expansion type with an electronic expansion valve to regulate refrigerant. Normally no maintenance or service work will be required.

Adjusting Refrigerant Charge

All ACC chillers are shipped with a full factory charge. Periodically additional charge may be required.

Charging a system in the field must be based on determination of liquid sub-cooling and evaporator superheat. On a system with an electronic expansion valve, liquid subcooling is more representative of the charge than evaporator superheat but both measurements must be taken.

Before Charging

Refer to the Unit Nameplate as a reference when determining the proper refrigerant charge.

Unit being charged must be at or near full load conditions before adjusting the charge.

After adding or removing charge the system must be allowed to stabilize, typically 10-15 minutes, before making any other adjustments.

The type of unit and options determine the ranges for liquid sub-cooling and evaporator superheat. Refer to Table 4 - Acceptable Refrigeration Circuit Values when determining the proper sub-cooling.

The type of unit and options determine the ranges for liquid sub-cooling and evaporator superheat. Refer to Table 4 - Acceptable Refrigeration Circuit Values when determining the proper sub-cooling.

Checking Liquid Sub-cooling

Measure the temperature of the liquid line as it leaves the condenser coil.

Read the gauge pressure at the liquid line close to the point where the temperature was taken. You must use liquid line pressure as it will vary from discharge pressure due to condenser coil pressure drop.

Convert the pressure obtained to a saturated temperature using the appropriate refrigerant temperature-pressure chart. Subtract the measured liquid line temperature from the saturated temperature to determine the liquid sub-cooling.

Compare calculated sub-cooling to **Error! Reference source not found.** for the appropriate unit type and options.

Checking Evaporator Superheat

Measure the temperature of the suction line close to the compressor.

Read gauge pressure at the suction line close to the compressor.

Convert the pressure obtained to a saturated temperature using the appropriate refrigerant temperature-pressure chart.

Subtract the saturated temperature from the measured suction line temperature to determine the evaporator superheat.

For refrigeration systems with tandem scroll compressors, it is critical that the suction

superheat setpoint on the expansion valve is set with one compressor running. The suction superheat should be 8-10°F with one compressor running. The suction superheat will increase with both compressors in a tandem running. Inadequate suction superheat can allow liquid refrigerant to return to the compressors which will wash the oil out of the compressor. Lack of oil lubrication will destroy a compressor. Liquid sub-cooling should be measured with both compressors in a refrigeration system running.

Compare calculated superheat to the acceptable cooling mode superheat values of 10-15°F for all system types and subcooling to range of 9-12°F.

	CAUTION
EXPANSION VALVE ADJUSTMENT	
Expansion valves must be adjusted to approximately 10-15°F of suction superheat. Failure to have sufficient superheat will damage the compressor and void the warranty.	

Table 4 - Acceptable Refrigeration Circuit Values

Air-Cooled Condenser	
Sub-Cooling	8-12 °F
Superheat	10-15 °F

Adjusting Sub-cooling and Superheat
Temperatures

The system is overcharged if the sub-cooling temperature is too high and the evaporator is fully loaded (low loads on the evaporator result in increased sub-cooling) and the evaporator superheat is within the temperature range shown in Table 4 - Acceptable Refrigeration Circuit Values (high superheat results in increased sub-cooling).

Correct an overcharged system by reducing the amount of refrigerant in the system to lower the sub-cooling.

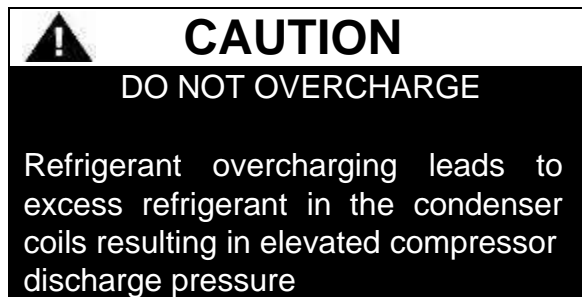

The system is undercharged if the superheat is too high and the sub-cooling is too low.

Correct an undercharged system by adding refrigerant to the system to reduce superheat and raise sub-cooling.

If the sub-cooling is correct and the superheat is too high, the expansion valve may need adjustment to correct the superheat.

Table 5 - R-410A Refrigerant Temperature-Pressure Chart

°F	PSIG	°F	PSIG	°F	PSIG	°F	PSIG	°F	PSIG
20	78.3	47	134.7	74	213.7	101	321.0	128	463.2
21	80.0	48	137.2	75	217.1	102	325.6	129	469.3
22	81.8	49	139.7	76	220.6	103	330.2	130	475.4
23	83.6	50	142.2	77	224.1	104	334.9	131	481.6
24	85.4	51	144.8	78	227.7	105	339.6	132	487.8
25	87.2	52	147.4	79	231.3	106	344.4	133	494.1
26	89.1	53	150.1	80	234.9	107	349.3	134	500.5
27	91.0	54	152.8	81	238.6	108	354.2	135	506.9
28	92.9	55	155.5	82	242.3	109	359.1	136	513.4
29	94.9	56	158.2	83	246.0	110	364.1	137	520.0
30	96.8	57	161.0	84	249.8	111	369.1	138	526.6
31	98.8	58	163.8	85	253.7	112	374.2	139	533.3
32	100.9	59	166.7	86	257.5	113	379.4	140	540.1
33	102.9	60	169.6	87	261.4	114	384.6	141	547.0
34	105.0	61	172.5	88	265.4	115	389.9	142	553.9
35	107.1	62	175.4	89	269.4	116	395.2	143	560.9
36	109.2	63	178.4	90	273.5	117	400.5	144	567.9
37	111.4	64	181.5	91	277.6	118	405.9	145	575.1
38	113.6	65	184.5	92	281.7	119	411.4	146	582.3
39	115.8	66	187.6	93	285.9	120	416.9	147	589.6
40	118.1	67	190.7	94	290.1	121	422.5	148	596.9
41	120.3	68	193.9	95	294.4	122	428.2	149	604.4
42	122.7	69	197.1	96	298.7	123	433.9	150	611.9
43	125.0	70	200.4	97	303.0	124	439.6		
44	127.4	71	203.6	98	307.5	125	445.4		
45	129.8	72	207.0	99	311.9	126	451.3		
46	132.2	73	210.3	100	316.4	127	457.3		

Lubrication

All original motors and bearings are furnished with an original factory charge of lubrication.

Service

If the unit will not operate correctly and a service company is required, only a trained service technician qualified and experienced in both refrigerant chillers and air conditioning is permitted to service the system to keep warranties in effect. If assistance is required, the service technician must contact Jetson.

Note: Service technician will need the model and serial number of the unit in all correspondence with Jetson factory.

Warranties

Please refer to the limitation of warranties in effect at the time of purchase.

Pump Operation

Before initial start of the pump, check as follows:

1. Be sure that pump operates in the direction indicated by the arrow on the pump casing. Check rotation each time motor leads have been disconnected.
2. Check all connections of motor and starting device with wiring diagram. Check voltage, phase and frequency of line circuit with motor name plate.
3. Check suction and discharge piping and pressure gauges for proper operation.
4. Turn rotating element by hand to assure that it rotates freely.

Running:

Periodically inspect pump while running, but especially after initial start-up and after repairs.

1. Check pump and piping for leaks. Repair immediately.
2. Record pressure gauge readings for future reference.
3. Record voltage, amperage per phase, and kW.

Maintenance Recommendations

Pump/Fan Motor Maintenance

Cleaning - Remove oil, dust, water, and chemicals from exterior of motor and pump. Keep motor air inlet and outlet open. Blow out interior of open motors with clean compressed air at low pressure.

Pump Bearings - Lubrication

Every 6 months or after a prolonged shut down, use waterproof, lithium-based grease. Below 32°F, use Esso Exxon or Beacon 325. Above 32°F, use Mobil Mobilox EP2, Shell Alvania EP2 or Texaco RB2.

Air Inlet

Inspect the air inlet into the condenser section on a monthly basis to remove any paper, leaves or other debris that may block the airflow.

Propeller Fans and Motors

The fans are directly mounted on the motor shafts and the assemblies require minimal maintenance except to assure they are clear of dirt or debris that would impede the airflow.

Recommended Annual Inspection

In addition to the above maintenance activities, a general inspection of the unit surface should be completed at least once a year.

Air-Cooled Condenser

The air-cooled condenser section rejects heat by passing outdoor air over the microchannel coils for cooling of the hot refrigerant gas from the compressors. The heated air will discharge from the top of the section through the axial flow fans.

The condenser coils should be inspected yearly to ensure unrestricted airflow. If the installation has a large amount of airborne dust or other material, the condenser coils should be cleaned with a water spray in a direction opposite to airflow. Care must be taken to prevent damage to the microchannel coil.

Microchannel Coil Cleaning

Documented routine cleaning of microchannel coils with factory provided E-coating is required to maintain coating warranty coverage. See E-Coated Coil Cleaning section.

Air-cooled heat exchangers include microchannel coils.

Cleaning microchannel coils is necessary in all locations. In some locations it may be necessary to clean the coils more or less often than recommended. In general, a condenser coil should be cleaned at a minimum of once a year. In locations where there is commonly debris or a condition that causes dirt/grease build up it may be

necessary to clean the coils more often. Proper procedure should be followed at every cleaning interval. Using improper cleaning technique or incorrect chemicals will result in coil damage, system performance degradation, and potentially leaks requiring coil replacement.

Documented routine cleaning of microchannel coils with factory provided E-coating is required to maintain coating warranty coverage. Use the E-Coated Coil Cleaning section for details on cleaning E-coated coils.

Field applied coil coatings are not recommended with microchannel coils.

Allowed Chemical Cleaners and Procedures

Jetson recommends certain chemicals that can be used to remove buildup of grime and debris on the surface of microchannel coils. These are the only chemicals that Jetson will warrant as correct for cleaning microchannel coils.

There are three procedures that are outlined following that will clean the coils effectively without damage to the coils. Use of any other procedure or chemical may void the warranty to the unit where the coil is installed. **With all procedures make sure the unit is off before beginning procedure.**

	WARNING
Electric shock hazard. Shut off all electrical power to the unit to avoid shock hazard or injury from rotating parts.	

The water pressure used to clean should not exceed 100 psi, from no closer than 6 inches

from the coils, and with the water aimed perpendicular to the coils.

#1 Simple Green

Simple Green is biodegradable with a neutral 6.5 pH. Recommendation is to use it at a 4 to 1 mix. Use the following procedure.

1. Rinse the coil completely with water. Use a hard spray but be careful not to bend or damage the fins. A spray that is too hard will bend the fins. Spray from the fan side of the coil.
2. With a pump sprayer filled with a mix of 4 parts water to one-part Simple Green spray the air inlet face of the coil. Be sure to cover all areas of the face of the coil.
3. Allow the coil to soak for 10-15 minutes.
4. Rinse the coil with water as in step one.
5. Repeat as necessary.

#2 Vinegar

This is standard white vinegar available in gallons from most grocery stores. It has a pH of 2-3, so it is slightly acidic. Use the following procedure.

1. Rinse the coil completely with water. Use a hard spray but be careful not to bend or damage the fins. A spray that is too hard will bend the fins. Spray from the fan side of the coil.
2. Use a pump sprayer filled with vinegar (100%). Spray from the face of the coil in the same direction as the airflow. Be sure to cover all areas of the face of the coil.
3. Allow the coil to soak for 10-15 minutes.
4. Rinse the coil with water as in step one.
5. Repeat as necessary.

#3 Water Flush

This procedure can be used when the only material to cause the coil to need cleaning is debris from plant material that has impinged the coil face.

1. Rinse the coil completely with water. Use a hard spray but be careful not to bend or damage the fins. A spray that is too hard will bend the fins. Spray from the fan side of the coil.
2. Spray and rinse the coil from the face.

	CAUTION
PRESSURE CLEANING	
Use pressurized clean water, with pressure not to exceed 100 psi. Nozzle should be 6" and 80° to 90° from coil face. Failure to do so could result in coil damage.	

Microchannel Coil Cleaning Considerations

The three procedures can be used to clean microchannel coils. The proper application will depend on the equipment's installation environment.

In areas where the spring/summer has a heavy bloom (i.e., cottonwood), method #3 may be the preferred cleaning method if the unit is installed on an office building and no other environmental factors apply.

If the unit is installed where a sprinkler system sprays onto the condenser, coil cleaning method #2 may provide best results. Vinegar is slightly acidic and may help with calcium build up. This also works well when grease is part of the inlet air to a condenser coil.

Generally, the broadest based method is #1. The grease cutting effect of the Simple Green is good for restaurant applications.

Other Coil Cleaners

There are many cleaners on the market for condenser coils. Before using any cleaner that is not covered in this section you must get written approval from the Jetson warranty and service department. Use of unapproved chemicals will void the warranty.

Unless a chemical has a neutral pH (6-8) it should not be used.

Beware of any product that claims to be a foaming cleaner. The foam that is generated is caused by a chemical reaction to the

aluminum fin, tube, and coating material on microchannel coils.

Microchannel coils are robust in many ways, but like any component they must be treated correctly. This includes cleaning the coils correctly to give optimal performance over many years.

E-Coated Coil Cleaning

Documented quarterly cleaning of e-coated coils is required to maintain coating warranty coverage.

	WARNING
Electric shock hazard. Shut off all electrical power to the unit to avoid shock hazard or injury from rotating parts.	

Surface loaded fibers or dirt should be removed prior to water rinse to prevent restriction of airflow. If unable to back wash the side of the coil opposite of the coils entering air side, then surface loaded fibers or dirt should be removed with a vacuum cleaner. If a vacuum cleaner is not available, a *soft non-metallic* bristle brush may be used. In either case, the tool should be applied in the direction of the fins. Coil surfaces can be easily damaged (fin edges bent over) if the tool is applied across the fins.

Use of a water stream, such as a garden hose, against a surface loaded coil will drive the fibers, dirt and salts into the coil. This will make cleaning efforts more difficult. Surface loaded fibers must be completely removed prior to using low velocity clean water rinse.

Quarterly cleaning is required to maintain warranty coverage and is essential to maintain the life of an E-coated coil. Coil cleaning shall be part of the unit's regularly scheduled maintenance procedures.

Failure to clean an E-coated coil on the prescribed quarterly cycle will void the warranty and may result in reduced efficiency and durability in the environment.

A routine two-step quarterly coil cleaning is required to maintain warranty.

Step one is to clean the coil with an approved coil cleaner listed in Microchannel Coil Cleaning.

Step two is to use the approved salt/chloride remover in the following section to dissolve soluble salts and revitalize the unit. It is very important when cleaning and/or rinsing not to exceed 130°F and potable water pressure is less than 100 psig to avoid damaging the unit and coil fin edges.

 CAUTION PRESSURE CLEANING
High velocity water from a pressure washer or compressed air should only be used at a very low pressure to prevent fin and/or coil damages. The force of the water or air jet may bend the fin edges and increase airside pressure drop. Reduced unit performance or nuisance unit shutdowns may occur.

 CAUTION CHEMICAL CLEANING
Harsh chemicals, household bleach, or acid cleaners should not be used to clean e-coated coils. These cleaners can be very difficult to rinse out of the coil and can accelerate corrosion and attack the e-coating. If there is dirt below the surface of the coil, use the recommended coil cleaners.

For routine quarterly cleaning, first clean the coil with the approved coil cleaner. After cleaning the coils with the approved cleaning agent, use the approved chloride remover to remove soluble salts and revitalize the unit.

Recommended Coil Cleaner – Step 1
GulfCoat™ Coil Cleaner, when used in accordance with the manufacturer's directions on the container for proper mixing and cleaning, this cleaner has been approved for use on E-coated coils to remove mold, mildew, dust, soot, greasy residue, lint and other particulate. Never use any cleaners that are not approved.

Recommended Chloride Remover – Step 2
CHLOR*RID® Concentrate, when used in accordance with the manufacturer's directions on the container for proper mixing, has been approved for use on E-coated coils to remove chlorides/salts & sulfates. Never use any chloride removers that are not approved.

Warranty Protection – Step 1 Complete the coil cleaning following these steps:

1. Ensure that the power to the unit is off and locked out.
2. Clean the area around the unit if needed to ensure leaves, grass or loose debris will not be blown into the coil.
3. Remove panels or tops as required gaining access to the coil(s) to be cleaned.
4. Using a pump-up sprayer, fill to the appropriate level with potable water and add the correct amount of approved cleaner as per manufacture instructions leaving room for the pump plunger to be reinserted.

NOTE: Coils should always be cleaned / back flushed, opposite of airflow to prevent impacting the dirt into the coil.

5. If the coils have heavy dirt, fibers, grass, leaves etc. on the interior or exterior face areas, a vacuum and brush should be used to remove those surface contaminants prior to applying cleaner. The interior floor, drain tray or pan areas should also be vacuumed.
6. Apply the mixed cleaner to coil surfaces using a pressurized pump-up sprayer maintaining a good rate of pressure and at a medium size nozzle spray, (not a solid stream and not a wide fan but somewhere in the middle). Work in sections/panels ensuring that all areas are covered and kept wetted.
7. Apply the cleaner to unit interior air exiting side coil surfaces first. Work in sections/panels moving side to side and from top to bottom.
8. Generously soak coils by spraying cleaner directly on and into the fin pack section to be cleaned and allow the cleaning solution to soak for 5 to 10 minutes.
9. Using pressurized potable water, (<100 psi), rinse the coils and continue to always work in sections/panels. Start at the top of the coil and slowly move vertically downward to the bottom. Then, staying in the same vertical area, slowly move back up to the top where you started. Now move over slightly overlapping the area just completed and repeat above. Continue until all coil areas on the inside of the unit have been rinsed.
10. Complete steps 5-9 for the exterior air entering side of the coils.
11. Final rinse – Now complete a quick rinse of both sides of the coil including the headers and piping.
12. If the coil has a drain pan or unit floor that is holding rinse water or cleaner, extra time and attention will need to be taken in those areas to ensure a proper rinse has been completed.

Warranty Protection – Step 2 Complete the coil chloride (salt) removal following these steps:

1. CHLOR*RID® is a concentrate to be used for both normal inland applications at a 100:1 mix ratio OR for severe coastal applications 50:1 mix ratio with potable water, (2.56 ounces of Chlor*rid to 1 gal of water). Using a pump-up sprayer, fill to the appropriate level with potable water and add the correct amount of

CHLOR*RID® salt remover leaving room for the pump plunger to be reinserted.

2. Apply CHLOR*RID® to all external coil surfaces using a pressurized pump-up sprayer maintaining a good rate of pressure and at a medium size nozzle spray, (not a solid stream and not a wide fan but somewhere in the middle). Work in sections/panels ensuring that all areas are covered and kept wetted.
3. Generously soak coils by spraying CHLOR*RID® directly on and into the fin pack section. Let stand for 5 to 10 minutes keeping the area wetted. Do not allow to dry before rinsing.
4. Using pressurized potable water, (<100 psi), rinse the CHLOR*RID® and dissolved chlorides/salts off of the coils continuing to always work in sections/panels.
5. Starting at the top of the coil, begin rinsing the coil from side to side until you reach the bottom. Repeat as many times as is necessary to ensure all coil sections/panels have been completed and are thoroughly rinsed.
6. Reinstall all panels and tops that were removed.

Limited Product Warranty

General Conditions

Jetson Innovations (hereinafter referred to as “Jetson”) warrants this equipment to be free of defects in material and workmanship under normal use, service, and maintenance. Our obligations under this warranty shall be limited to repairing or replacing the defective part, or parts, which in our judgment show evidence of such defects. Jetson is not liable for labor charges and other costs incurred for removing, shipping, handling or transporting defective part, or parts, or for shipping, handling, transporting, or installing repaired or replacement part, or parts.

The limited warranty is effective one (1) year from date of original installation, or eighteen (18) months from date of original shipment from the factory, whichever occurs first and covers all parts and components in this Jetson equipment excluding refrigerant moisture driers and lost refrigerant, which are not included in any part of this limited warranty. The replacement part, or parts, assume only the unused portion of the original limited warranty and are shipped f.o.b. from the factory and freight prepaid by the factory.

The limited warranty is effective for products manufactured at the Longview, Texas facility.

THIS LIMITED WARRANTY ONLY APPLIES WHEN THE ORIGINAL MODEL NUMBER AND SERIAL NUMBER OF THE JETSON UNIT ARE GIVEN AT TIME OF REQUEST FOR REPLACEMENT PART, OR PARTS. DEFECTIVE PART, OR PARTS, MUST BE RETURNED PREPAID, WITH ITS ASSIGNED RETURN MATERIAL TAG, WITHIN FOURTEEN (14) DAYS OF RECEIPT OF THE REPLACEMENT PART, OR PARTS.

This warranty does not cover and does not apply to:

1. Fuses, refrigerant, fluids, oil;
2. Products relocated after initial installation;
3. Any portion or component of the system that is not supplied by Jetson, regardless of the cause of the failure of such portion or component;
4. Products on which the unit’s identification tags or labels have been removed or defaced;
5. Products on which payment to Jetson is or has been in default;
6. Products which have defects or damage which result from improper installation, wiring, electrical imbalance characteristics or maintenance (including, without limitation, defects or damages caused by voltage surges, inadequate voltage conditions, phase imbalance, any form of electrical disturbances, inadequate or improper electrical circuit installation or protection, failure to perform common maintenance, etc.); or are caused by accident, misuse or abuse, fire, the elements, shock, vibration, flood, alteration, misapplication of the product or to any other service, range or environment of greater severity than that for which the products were designed;
7. Products which have defects or damage which result from a contaminated or corrosive air or liquid supply, operation at abnormal temperatures, or unauthorized opening of refrigerant circuit;
8. Products subjected to corrosion or abrasion or chemicals;

9. Mold, fungus or bacteria damage;
10. Products manufactured or supplied by others;
11. Products which have been subjected to misuse, negligence, vandalism or accidents;
12. Products which have been operated in a manner contrary to Jetson written instructions;
13. Products which have defects, damage or insufficient performance as a result of insufficient or incorrect system design or the improper application of Jetson products;
14. Products which have defects or damages due to freezing of the water supply, an inadequate or interrupted water supply, corrosives or abrasives in the water supply, or improper or inadequate filtration or treatment of the water or air supply.
15. Water-to-refrigerant heat exchanger for any damage resulting from freezing, fouling, corrosion or clogging.
16. A unit which has been installed outside of the Continental United States or Canada.

Jetson shall not be liable for any default or delay in performance hereunder, caused by a contingency beyond its control, including governmental restrictions or restraint, strikes, short or reduced supply of raw materials or parts, floods, winds, fire, lightning strikes, or any other acts of God.

DISCLAIMERS OF WARRANTIES

THIS WARRANTY IS EXCLUSIVE AND IS IN LIEU OF ANY WARRANTY OF MERCHANTABILITY, FITNESS FOR A PARTICULAR PURPOSE OR OTHER WARRANTY OF QUALITY, WHETHER EXPRESS OR IMPLIED, EXCEPT OF TITLE AND AGAINST PATENT INFRINGEMENT, CORRECTION OF NON-CONFORMITIES ARE LIMITED TO REPAIR OR REPLACEMENT OF THE DEFECTIVE PART OR PARTS, AT SELLER'S OPTION, WHICH SHALL CONSTITUTE FULFILLMENT OF ALL TORT OR OTHERWISE IT IS EXPRESSLY UNDERSTOOD THAT JETSON SHALL NOT BE LIABLE FOR ANY CONSEQUENTIAL OR INCIDENTAL DAMAGES. JETSON SHALL NOT UNDER ANY CIRCUMSTANCES BE LIABLE FOR SPECIAL, INCIDENTAL OR CONSEQUENTIAL DAMAGES, SUCH AS, BUT NOT LIMITED TO DAMAGES OR LOSS OF OTHER PROPERTY OR EQUIPMENT, LOSS OF PROFITS OR REVENUE, COST OF CAPITAL, COST OF PURCHASED OR REPLACEMENT GOODS, OR CLAIMS OF BUYER OR USER FOR SERVICE INTERRUPTIONS. THE REMEDIES OF THE BUYER SET FORTH HEREIN ARE EXCLUSIVE, AND THE LIABILITY OF JETSON WITH RESPECT TO ANY CONTRACT, OR ANYTHING DONE IN CONNECTION THEREWITH SUCH AS THE PERFORMANCE OR BREACH THEREFORE, OR FROM THE MANUFACTURE, SALE, DELIVERY, RESALE, INSTALLATION, OR USE OF ANY GOODS COVERED BY OR FURNISHED UNDER THIS CONTRACT WHETHER ARISING OUT OF CONTRACT, NEGLIGENCE, STRICT TORT, OR UNDER ANY WARRANTY, OR OTHERWISE, SHALL NOT EXCEPT AS EXPRESSLY PROVIDED HEREIN, EXCEED THE PRICE OF THE GOODS UPON WHICH SUCH LIABILITY IS BASED.

WITH RESPECT TO THE GOODS SOLD, THE BUYER HEREBY WAIVES ALL LIABILITY ARISING FROM STATUTE, LAW, STRICT LIABILITY IN TORT, OR OTHERWISE, INCLUDING WITHOUT LIMITATION ANY OBLIGATION OF JETSON WITH RESPECT TO CONSEQUENTIAL OR INCIDENTAL DAMAGES AND

WHETHER OR NOT OCCASIONED BY JETSON NEGLIGENCE. TIME LIMIT ON COMMENCING LEGAL ACTIONS: AN ACTION FOR BREACH OF THIS CONTRACT FOR GOOD SOLD OR ANY OTHER ACTION OTHERWISE ARISING OUT OF THIS CONTRACT, MUST BE COMMENCED WITHIN ONE (1) YEAR FROM THE DATE, THE RIGHT, CLAIM, DEMAND OR CAUSE OF ACTION SHALL FIRST OCCUR, OR BE BARRED FOREVER.

SEVERABILITY

IF ANY PROVISION OR CAUSE OF THIS CONTRACT OR APPLICATION THEREOF TO ANY PERSON OR CIRCUMSTANCES IS HELD INVALID OR UNCONSCIONABLE SUCH INVALIDITY OR UNCONSCIONABILITY SHALL NOT AFFECT OTHER PROVISIONS OR APPLICATIONS OF THE CONTRACT WHICH CAN BE GIVEN EFFECT WITHOUT THE INVALID OR UNCONSCIONABLE PROVISIONS OF THE CONTRACT ARE DECLARED BE SEVERABLE.

ACC Chillers Startup Form

Job Name: _____	Date: _____
Address: _____	
Model Number: _____	
Serial Number: _____	Tag: _____
Startup Contractor: _____	
Address: _____	
Phone: _____	

Pre-Startup Checklist

Installing contractor should verify the following items.

- | | | | | |
|---|--------------------------|-----|--------------------------|----|
| 1. Is there any visible shipping damage? | <input type="checkbox"/> | Yes | <input type="checkbox"/> | No |
| 2. Is the unit level? | <input type="checkbox"/> | Yes | <input type="checkbox"/> | No |
| 3. Are the unit clearances adequate for service and operation? | <input type="checkbox"/> | Yes | <input type="checkbox"/> | No |
| 4. Do all access doors open freely and are the handles operational? | <input type="checkbox"/> | Yes | <input type="checkbox"/> | No |
| 5. Have all shipping braces been removed? | <input type="checkbox"/> | Yes | <input type="checkbox"/> | No |
| 6. Have all electrical connections been tested for tightness? | <input type="checkbox"/> | Yes | <input type="checkbox"/> | No |
| 7. Does the electrical service correspond to the unit nameplate? | <input type="checkbox"/> | Yes | <input type="checkbox"/> | No |
| 8. On 208/230V units, has transformer tap been checked? | <input type="checkbox"/> | Yes | <input type="checkbox"/> | No |
| 9. Has overcurrent protection been installed to match the unit nameplate requirement? | <input type="checkbox"/> | Yes | <input type="checkbox"/> | No |
| 10. Have all set screws on the fans been tightened? | <input type="checkbox"/> | Yes | <input type="checkbox"/> | No |
| 11. Do all fans rotate freely? | <input type="checkbox"/> | Yes | <input type="checkbox"/> | No |
| 12. Does the field water piping to the unit appear to be correct per design parameters? | <input type="checkbox"/> | Yes | <input type="checkbox"/> | No |

Ambient Temperature

Ambient Dry Bulb Temperature _____ °F	Ambient Wet Bulb Temperature _____ °F
---------------------------------------	---------------------------------------

Chiller Operation

Chilled Water In Temperature _____ °F	Chilled Water Out Temperature _____ °F
---------------------------------------	--

Water/Glycol System

- 1. Has the entire system been flushed and pressure checked? Yes No
- 2. Have isolation valves to the chiller been installed? Yes No
- 3. Has the entire system been filled with fluid? Yes No
- 4. Has air been bled from the heat exchangers and piping? Yes No
- 5. Is there a minimum load of 25% of the design load? Yes No
- 6. Has the water piping been insulated? Yes No
- 7. Is the glycol the proper type and concentration (N/A if water)? Yes No
- 8. What is the freeze point of the glycol (N/A if water)?

Compressors/DX Cooling

<input type="checkbox"/> Check Rotation							
Number	Model #	L1	L2	L3	Head Pressure PSIG	Suction Pressure PSIG	Crankcase Heater Amps
1							
2							
3							
4							

Refrigeration System 1 - Cooling Mode

	Pressure	Saturated Temperature	Line Temperature	Sub-cooling	Superheat
Discharge				N/A	N/A
Suction				N/A	
Liquid					N/A

Refrigeration System 2 - Cooling Mode

	Pressure	Saturated Temperature	Line Temperature	Sub-cooling	Superheat
Discharge				N/A	N/A
Suction				N/A	
Liquid					N/A

Condenser Fans

<input type="checkbox"/> Alignment		<input type="checkbox"/> Check Rotation		Nameplate Amps _____	
Number	hp	L1	L2	L3	
1					
2					
3					
4					

Pumping Package

Number	hp	L1	L2	L3	Flow (gpm)
1					
2					

Literature Change History

07/01/20 – Initial version of document.

03/01/21 – Update electrical diagram and service clearances.

08/01/21 – Added warranty text.

10/11/21 – Updated product images and model string to match catalog

01/03/22 - Updated digit 29 isolation valve description to move second valve from suction line to liquid line. Added variable flow bypass text. Removed “labeled motors” paragraph.

THIS PAGE INTENTIONALLY BLANK



**905 W. Cotton Street
Longview, TX 75604
Phone: 903-758-2900
www.JetsonHVAC.com**

**ACC chillers
Installation, Operation, & Maintenance
Revision 220103**

Factory Technical Support: 903-758-2900

Note: Before calling Technical Support, please have the model and serial number of the unit available.

Parts: For replacement parts, please contact your local Jetson Representative.

It is the intent of Jetson to provide accurate and current product information. However, in the interest of product improvement, Jetson reserves the right to change pricing, specifications, and/or design of its product without notice, obligation, or liability.

Copyright © Jetson, all rights reserved throughout the world.